

Art. 2968

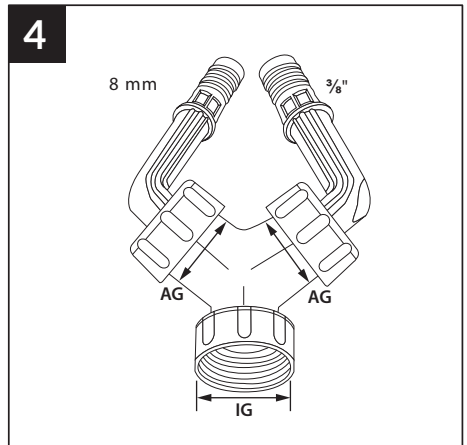
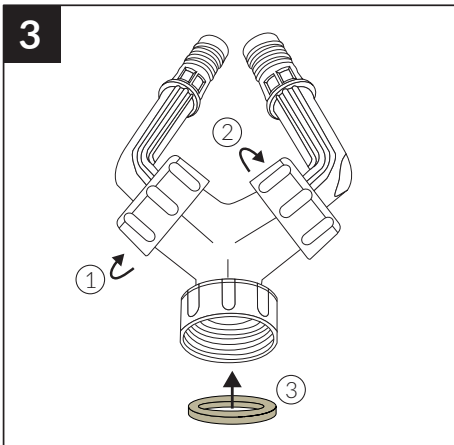
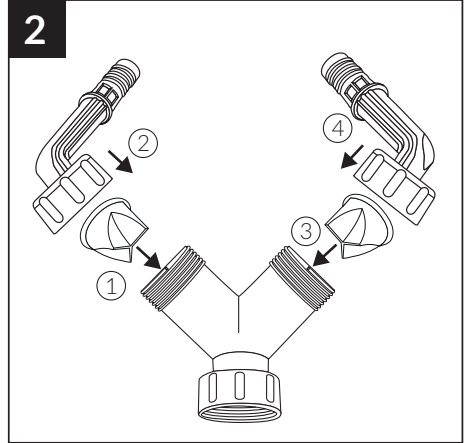
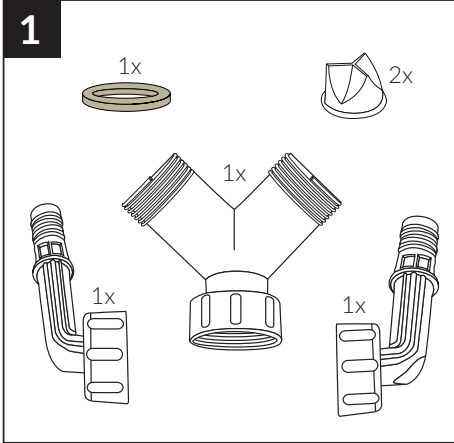

AG = 1"
IG = 1"